

# SPEAK UP

– Digital kaffe med faglig påfyll



# Project Department

---



**Alf Eidsvik**  
*Director projects*

[Alf.eidsvik@scaleaq.com](mailto:Alf.eidsvik@scaleaq.com)  
+47 40444769

51 years old  
Living in Uskedalen  
Married  
2 kids 16 and 18 years

- Started in Scale Feb 2019
- 23 years experience from shipyard on all level
- 9 years experience building and restructure of global companies
- Member of global mangement 9 years
- Last position VP lifesaving division palinger and MD palfinger safety



# Project Department

## Organisation

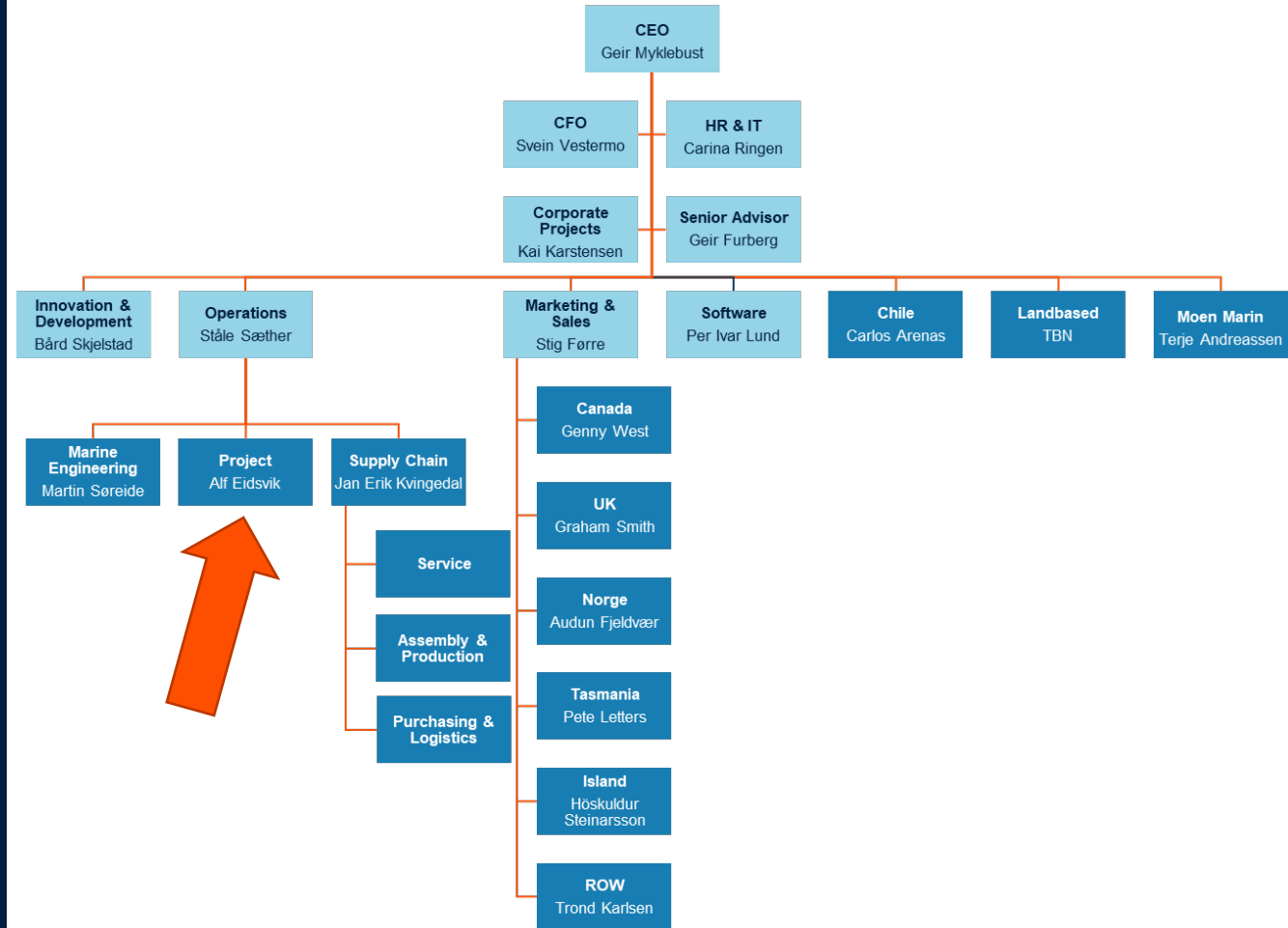



# Project Department

## Organisation

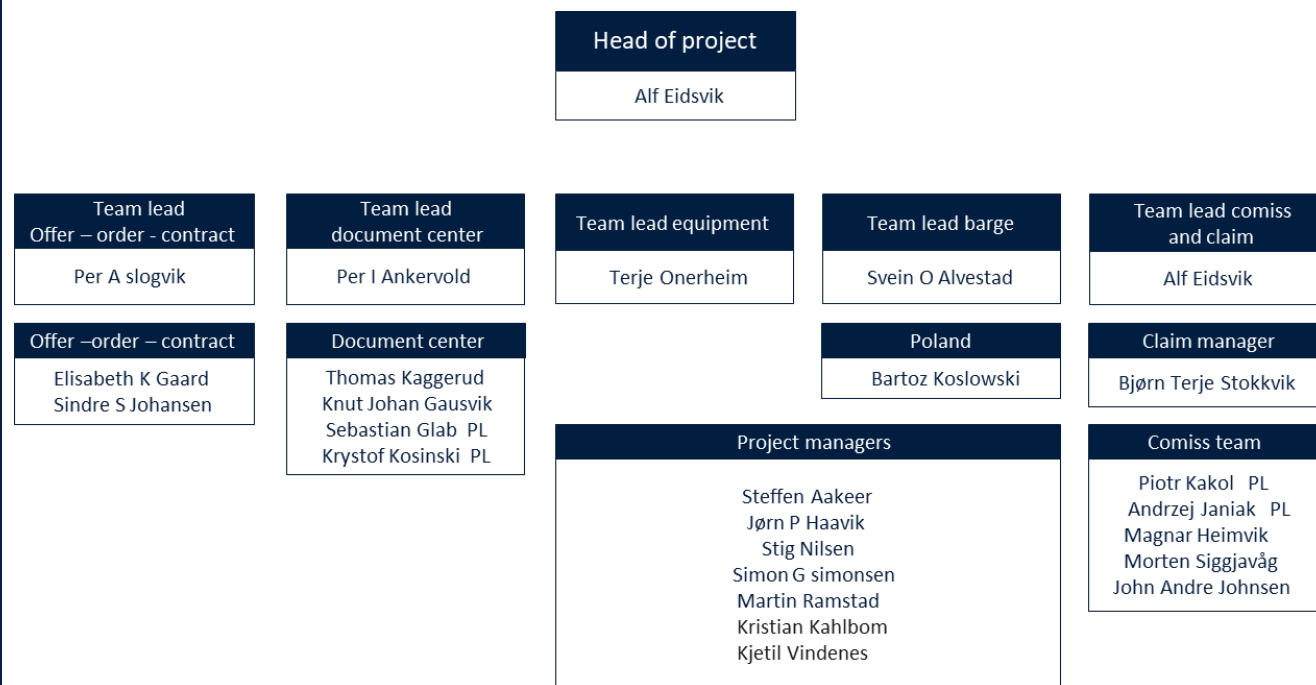



# Project Department

## Tasks and responsibility



*Project department goal and comittment is to support sale best possible perform and deliver all projects on time with best possible cost and quality - happy customer and no claims*

- ✓ Support and supply calculation – offers and contract to sales department
- ✓ Prepare and produce all order documentation
- ✓ Perform all projects in best possible way A to Z
- ✓ Follow up subcontractors
- ✓ Extensive cost control
- ✓ Reporting internaly and externaly
- ✓ Responsible for installation and comissioning
- ✓ Responsible for claim in warranty period
- ✓ Product responsibility barges
- ✓ Product responsibility thermolicer
- ✓ Comittment to scale up 250



# Project Department

From start to finish line

## TEAMWORK IN SCALE

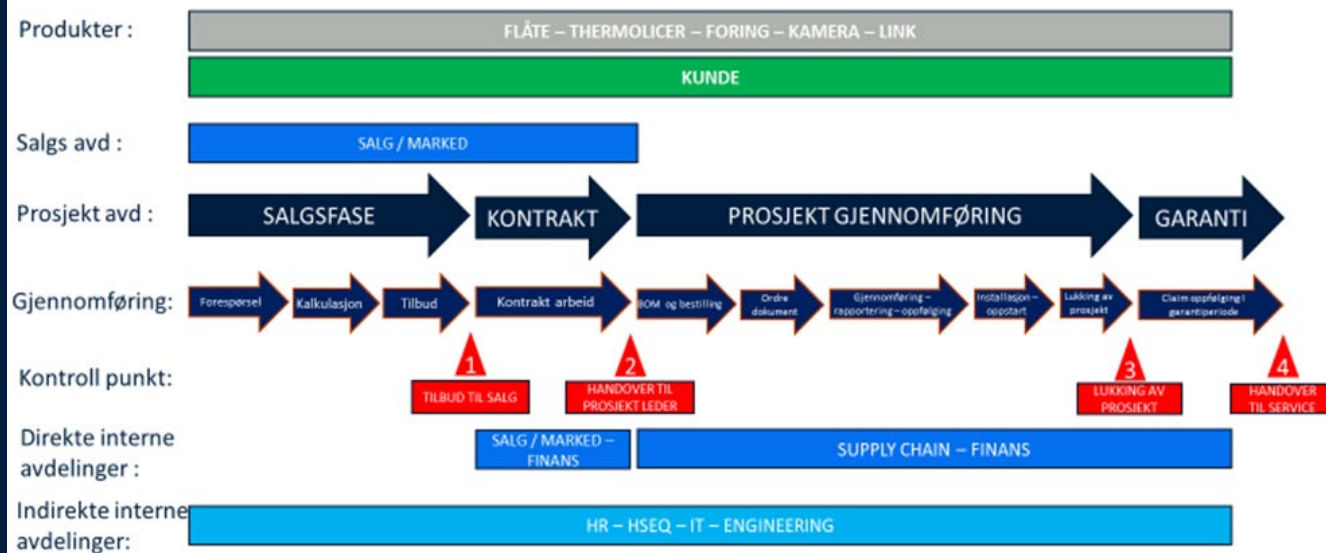



# Project Department

Orderbook and reporting

## FACTS 2020

- Approx 120 rolling projects
- Value 700 mill
- Orderbacklog will end up on approx 200 mill
- Increasing margin in the orderbook
- Approx 300 project offers are made
- Warranty claims is going down
- On time delivery

The image shows a collage of overlapping spreadsheets representing project data. The spreadsheets are color-coded with yellow and blue headers. Several project names are highlighted with white labels: 'FORING', 'FLÅTER', 'THERMOLICER', and 'KAMERA'. The tables contain columns for project ID, description, status, and various financial metrics.



# Project Department

Offer , order and  
contract team



*Support sales and deliver high quality offer  
and contractual documents*

- ✓ Support sales department
- ✓ Coordination of leasing
- ✓ Create offer document
- ✓ Calculation controle
- ✓ Facilitate handovers
- ✓ Prepare contract documents
- ✓ Participate in customer meeting
- ✓ Support project team
- ✓ Create Standard documents



Per Andreas Slogvik  
Team lead

Haugesund



Elisabeth Gaard Kvaale

Haugesund



Sindre Dankel Seim

Haugesund





# Project Department

Doc center team



*Doc center is constantly seeking for optimisation and stadardisation of products*

- ✓ technical offer documents
- ✓ order documentation
- ✓ Approval doc for class
- ✓ Final documentaion
- ✓ Participate in customer meeting
- ✓ Support project team
- ✓ Optimize barge and Thermolicer 3 D



Per Inge Ankervold  
Team lead

Haugesund



Thomas Kaggerud

Haugesund



Knut Johan Gausvik

Haugesund



Krzysztof Kosinski

Poland Gdynia



Sebastian Glab

Poland Gdynia



# Project Department

Doc center  
3 D modeling

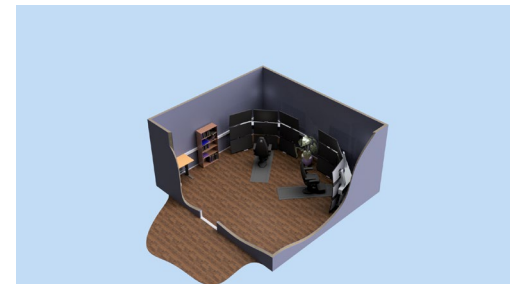
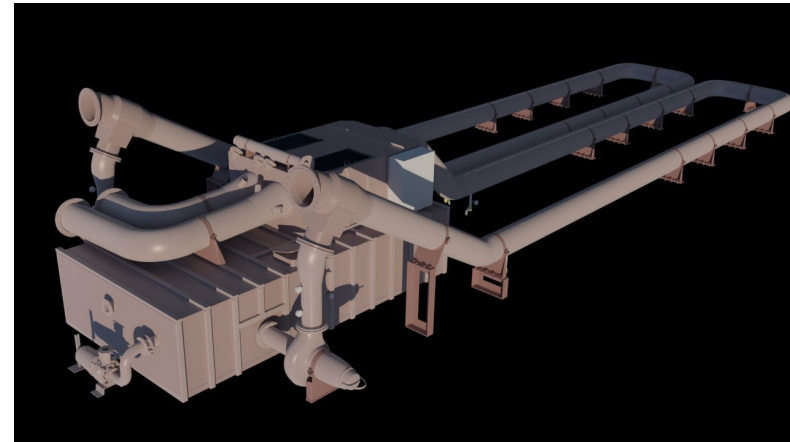
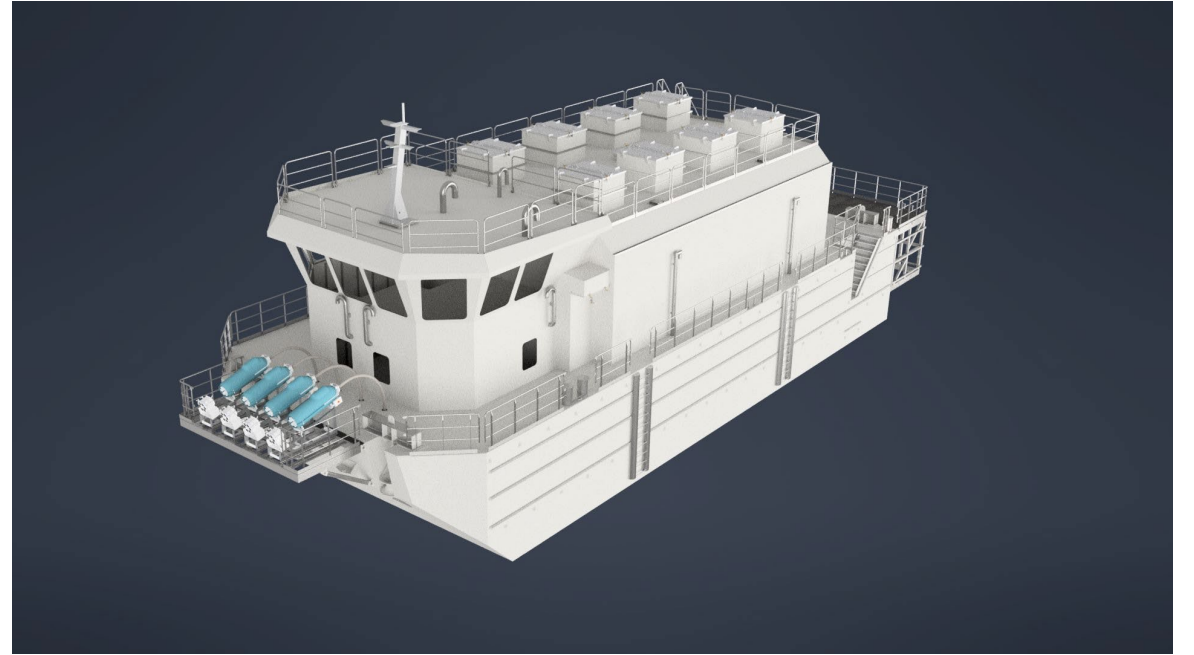









# Project Department

Comiss and claim team

- ✓ Quick respond
- ✓ Customer focus
- ✓ Cost focus
- ✓ Quality focus
- ✓ Inspection
- ✓ Installation
- ✓ Fat and Sat
- ✓ Customer training
- ✓ Support
- ✓ Reporting
- ✓ HSEQ focus



” Goal is to be remebered for the problem solving and not the problem it self , satisfied customer is the driver

	<p>Bjørn Terje Stokkvik Claim manager Haugesund</p>
	<p>Morten Siggjarvåg ( starts 04.01.21 ) Haugesund</p>
	<p>Magnar Heimvik ( starts 04.01.21 ) Haugesund</p>
	<p>John Andre Johnsen ( starts 01.04.21 ) Haugesund</p>
	<p>Piotr Kakol Poland Gdynia</p>
	<p>Andrzej Janiak Poland Gdynia</p>



# Project Department

Team Poland

” *Local presence at production site*

- ✓ Doc center
- ✓ Comiss team
- ✓ Production follow up
- ✓ Quality control
- ✓ Testing
- ✓ Local purchasing
- ✓ Reporting
- ✓ Support project team
- ✓ HSEQ focus





# Project Department

## Project team



*Right price – high quality and on time delivery is the goal*

- ✓ Support sales department
- ✓ Calculation
- ✓ Project management
- ✓ Cost control
- ✓ Quality control
- ✓ Reporting
- ✓ Production follow up
- ✓ Single project contact for customer
- ✓ Risk and HSEQ management
- ✓ Hand over to customer



Svein O Alvestad  
Team lead barge

Haugesund



Terje Onerheim  
Team lead equipment

Haugesund



Bartoz Koslowski  
Team lead Poland

Poland Gdynia



Steffen Aakeer

Haugesund



Jørn P L Haavik

Haugesund



Stig Nilsen

Haugesund



Simon G Simonsen

Haugesund



Martin Ramstad

Haugesund



Kristian Kahlbom

Haugesund



Kjetil Vindenes

Haugesund



# Project Department

## Feeding projects



Feeding system is transporting pellets from silos to the cages. No food no fish

- ✓ 3 main type of feeding projects
- ✓ Rebuilding and modification of existing
- ✓ Extension of existing
- ✓ New system on barges
- ✓ Rebuild and extension also of other than our own systems
- ✓ 55 projects done this year
- ✓ Value of this projects approx 39 mill

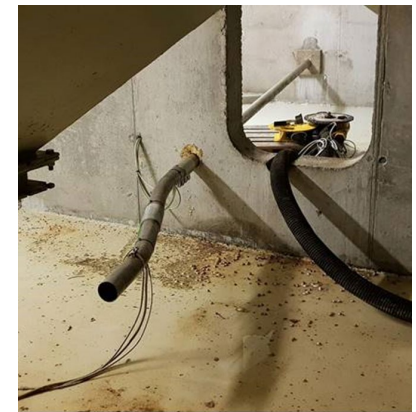



# Project Department

## Camera projects



Camera projects is complete surveillance system for the fish farm industry

- ✓ 46 projects done this year
- ✓ Value of this projects approx 30 mill
- ✓ 90 % of total camera projects is digital camera system
- ✓ 70 % of this is wireless

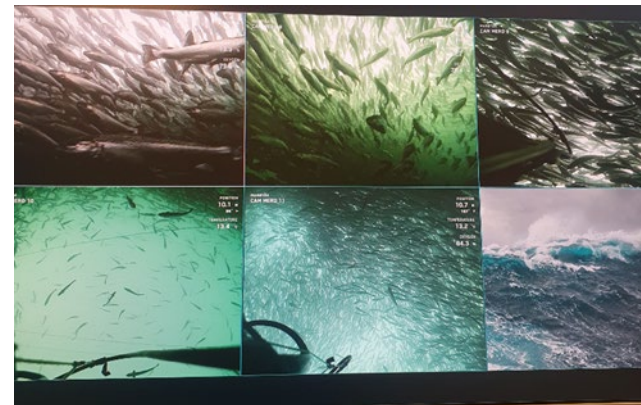
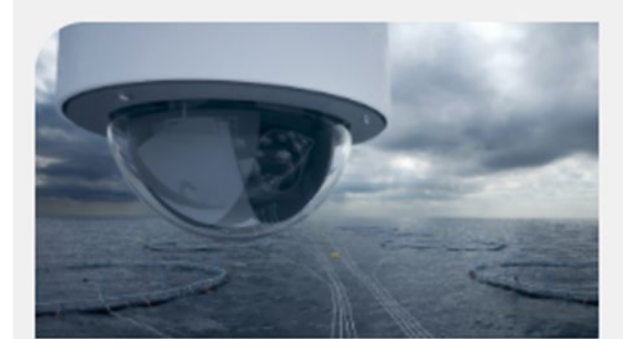
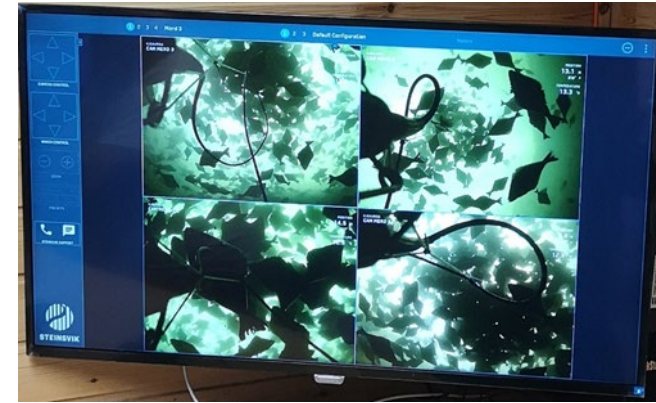

Orbit HD Surface



# Project Department

Remote projects



*Research and Development is necessary to ensure integrity of our structures. Continuous test programmes are established*

- ✓ Increase in complete solution projects
- ✓ Controlroom
- ✓ Link
- ✓ Combined with other products in our portfolio



## Remote Operations

- Building the required infrastructure to transport data from A to B
  - Getting to internet access point to route traffic through public network (if available)
  - Dedicated wireless links if nothing else is available

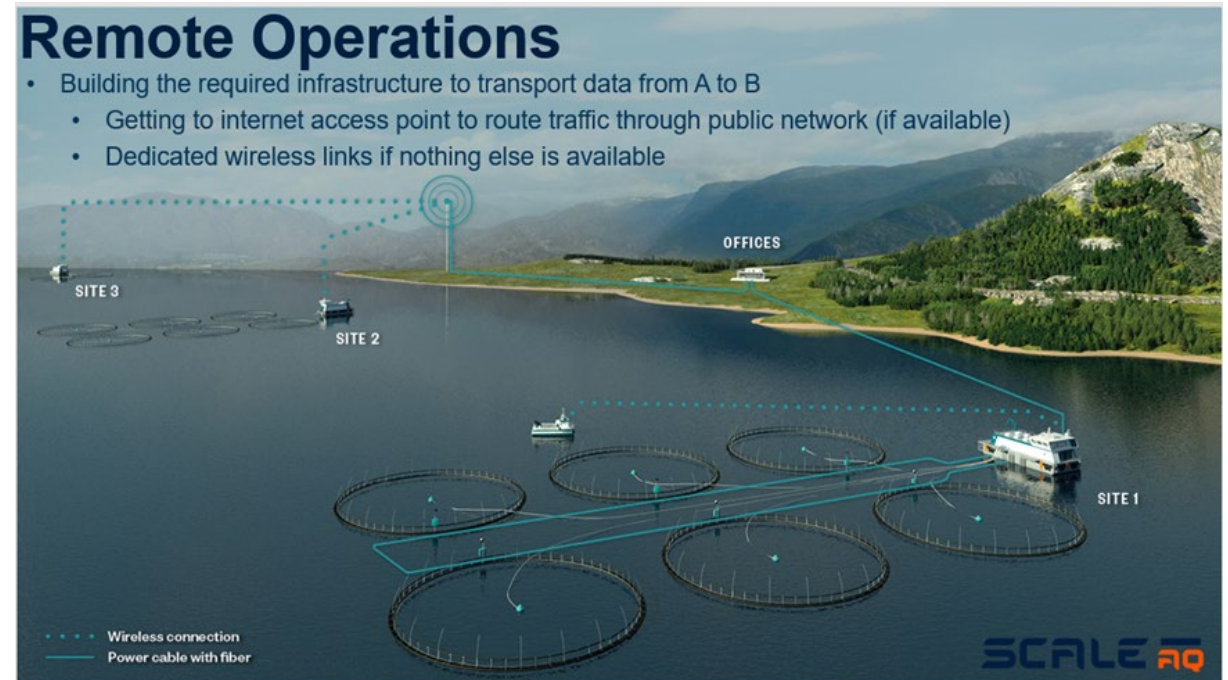



# Project Department

Hybrid projects



*Scale focus on environment*

- ✓ Delivered on new barges
- ✓ Retrofit of old barges
- ✓ Sold approx 10 Hybrid projects
- ✓ Approx value of 20 mill
- ✓ Several projects up running

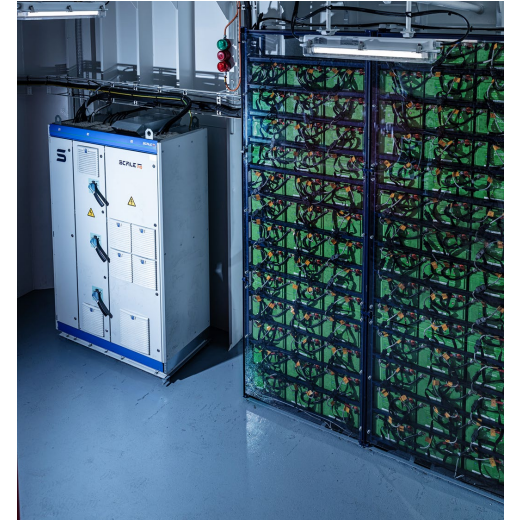



# Project Department

## Barges – Facts



*Barge is a feeding machine but also a start platform for future business and customer relation*

- ✓ 11 barges delivered in 2020
- ✓ 9 barges under construction at the moment
- ✓ Total value 500 mill
- ✓ Concrete barges 450 – 750
- ✓ steel barges 100 – 900 tonnes
- ✓ Production sites in Norway – Poland – Estonia – Vietnam
- ✓ Installed base of barges is approx 280 barges



Svein O Alvestad  
Team lead barge

Haugesund





# Project Department

Barge Models

Active

## Nova Concrete

- Nova Concrete
- Produced in 2 different tonnages 450 and 750 tonnes
- Sold in total 10 pcs
- HS up to 5,5



## Fram

- Boat barge and center barge in sizes of 100 – 200 – 300 – 400 - 500 tonn
- Sold in total of 87 pcs
- HS up to 4,8





# Project Department

Barge Models

Inactive

Considered on request

## Nova

- 300-600 tonn
- Vietnam / Chile modell – 480/600 tonn, 19-21 persons accomodation
- Delivered approx 25 of Nova barges

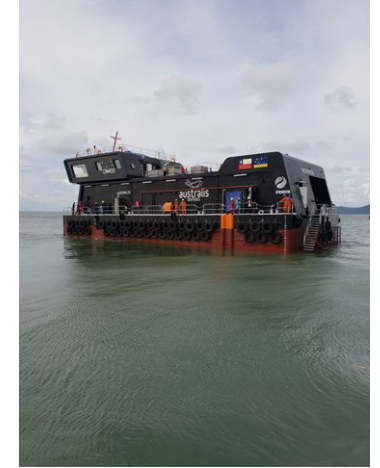
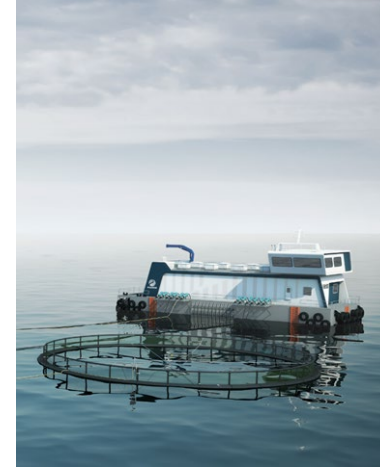

## Classic

- Classic is sold as 200 – 300 – 400 – 600 - 750 tonn
- Installed base of classic is approx 150 pcs





# Project Department

Barge Models

On going development



Scale barge , new generation barge for harsh weather condition

- ✓ HS from 5 – 6,5
- ✓ Capacity 600 – 900 tonnes
- ✓ Boat barge
- ✓ Center barge
- ✓ Sattelite barge

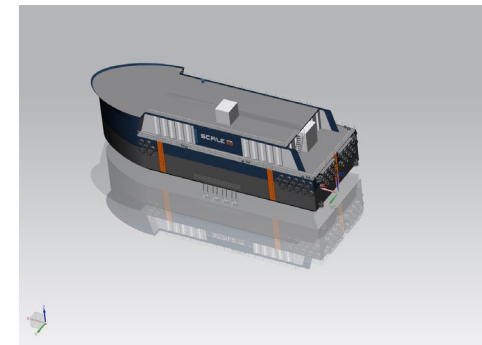



# Project Department

Barges – approval and control

By having well proven design with high intern control and 3. partie approval we build trust world wide

## Barge built and certified according NS9415 and Nytek

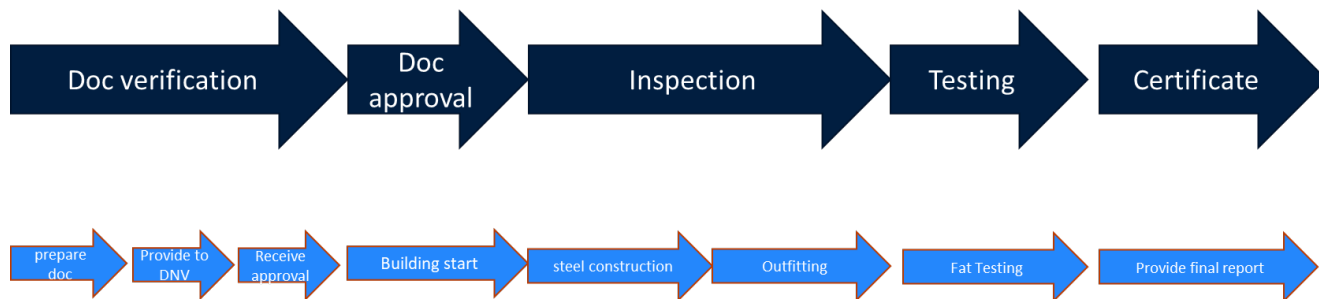



# Project Department

## Thermolicer Facts



Thermolicer is a process system for delicing of salmon and trout done at the fish farm



Terje Onerheim  
Team lead equipment

Haugesund

- ✓ To type of Thermolicer solutions Compact in 25 ft
- ✓ container ( TL 1.0 and 2.0 )
- ✓ Stretched pipe loop ( TL 3.0 )
- ✓ Treatment capacity 90 – 350t
- ✓ 9 pcs of Thermolicer in production at the moment
- ✓ Total value of 110 mill
- ✓ Production sites in Norway
- ✓ Customized and integration to ship
- ✓ Installed base of Thermolicer is approx 44 pcs

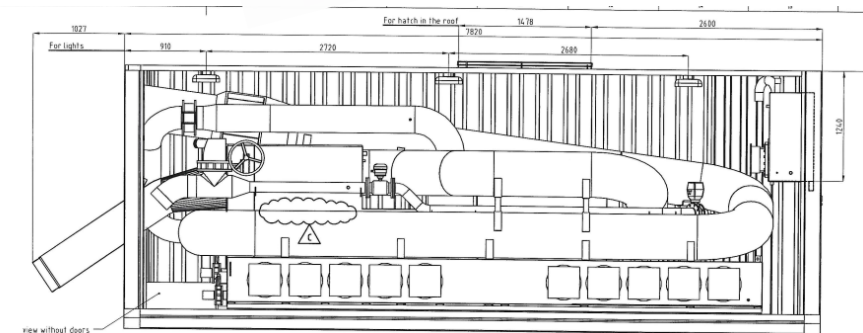
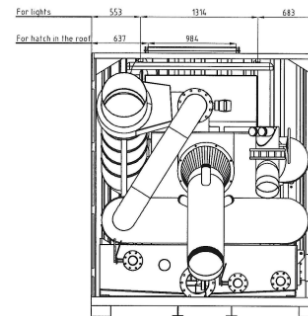
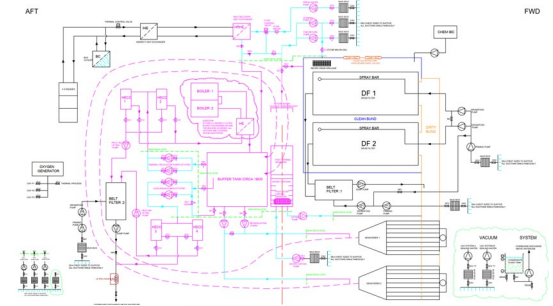



# Project Department

Thermolicer projects





# Project Department

New office in  
Haugesund





# Various deliveries

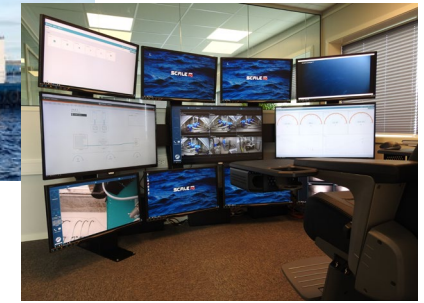
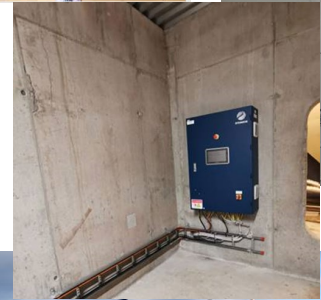

Ocea Feedstation converted to NGF  
Kabinett størrelser kan variere

